

**META Washstand fitting with electronic opening and closing function without pop-up waste - Chrome**







META

44 515 660



- Infrared sensor technology
- 125mm projection
- height of mixer 140 mm
- height up to aerator 52 mm
- hole diameter 35 mm
- fixed spout
- max. flow 5.7 l/min
- circular, air-enriched flow
- suitable for thermal disinfection
- Automatic shut-off after pre-set time is reached
- Direct temperature control at faucet
- Battery-powered (batteries not included)
- 1x CR-P2 battery required
- lead-free
- 2x screw-in M 8 x 1 pressure hose, leak-tested
- This product can help a building meet the requirements of Green Building Rating Systems, e.g. LEED®, BREEAM®, DGNB

Batteries not included

	Chrome	44 515 660-00
	Brushed Platinum	44 515 660-06
	Platinum	44 515 660-08
	Dark Chrome	44 515 660-19
	Light Gold	44 515 660-26
	Brushed Light Gold	44 515 660-27
	Brushed Durabronze (23kt Gold)	44 515 660-28
	Matte Black	44 515 660-33
	Brushed Bronze	44 515 660-42
	Brushed Champagne (22kt Gold)	44 515 660-46
	Champagne (22kt Gold)	44 515 660-47
	Brushed Chrome	44 515 660-93
	Brushed Dark Platinum	44 515 660-99

44 515 660  
mm [inches]

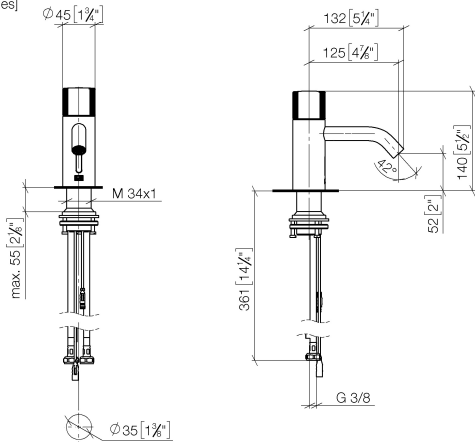

**Flow rate chart**



**Certificates**

LGA\_38243.

WRAS\_2212021.

44 515 660

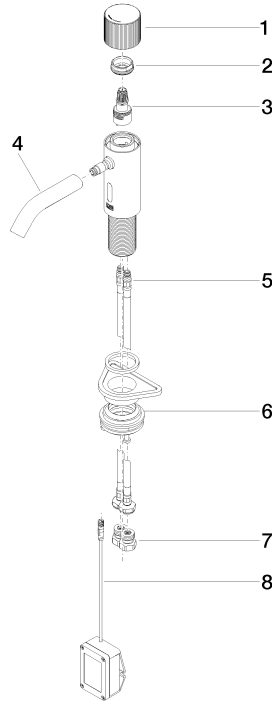

### Spare parts list

No.	Item Number	Name	Quantity used	Delivery time
1	90 20 66 124 00-00	handle	1	10
2	09 24 04 562 90	nut	1	60
3	90 90 03 173 00 90	top	1	2
4	90 11 06 206 00-00	spout	1	10
5	04 30 04 100 00 90	hose	2	2
6	04 23 10 044 08 90	fixing set	1	2
7	90 24 03 314 00 90	nipple set	2	2
8	90 10 01 250 00 90	casingwithout battery	1	2